

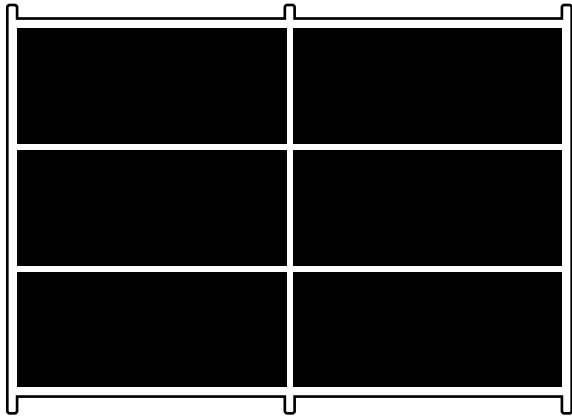

# d2

D2 by Gonzalez  
Haase AAS &  
Diez Office

Workbook



**d2**

Es ist Zeit für nachhaltige Möbelsysteme.  
It's time for sustainable furniture systems.

# WAGNER D2 System

D2 wird als Masterpieces in zwei Serienvarianten aus Aluminium angeboten. Darüber hinaus wird von Wagner die Planung und der Verbinder, sowie das Aluminiumprofil einzeln und nicht als fertiges Möbelstück angeboten. Der Verbinder ist bereits zum Patent angemeldet.

Bei diesem Konzept geht es darum eine Infrastruktur aufzubauen, die lokale Handwerker, Architekten und Kunden miteinander in Kontakt bringt; Transport und Lagerkosten sollen optimiert werden. Handwerker vor Ort übernehmen später die Produktion und den Aufbau der Möbelstücke. Am Ende soll echtes Recycling der Möbel erreicht werden.

D2 is offered as Masterpieces in two series variants made of aluminium. In addition, Wagner offers Wagner offers the planning and the connector as well as the aluminium profile individually and not as a finished piece of furniture. The connector is already patent pending.

This concept is about building an infrastructure that brings local craftsmen, architects and customers into contact with each other; transport and storage costs are to be optimised. Local craftsmen later take over the production and assembly of the furniture. In the end, the aim is to recycling of the furniture is to be achieved.

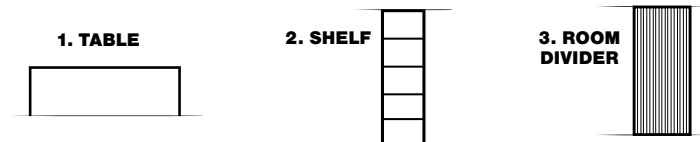



## Philosophie – Recycling als zentraler Bestandteil

## Philosophy – Recycling is the key element

D2 ist ein parametrisches Möbelsystem aus handelsüblichen Aluminium- oder Kartonleichtbauplatten. Im Sinne der Kreislaufwirtschaft sind diese beiden Materialien, anders als vergleichbare Plattenwerkstoffe, aktuell als einzige sortenrein recyclebar. Mit einem speziell entwickelten Beschlag aus Polyamid, dazu passenden Aluminiumprofilen und Rückwänden aus transluzentem Polycarbonat können die Platten werkzeuglos zu Regalen und maßgeschneiderten Raumlösungen zusammengefügt werden.

D2 is a parametric furniture system made from commercially available lightweight aluminium or cardboard panels. In terms of the circular economy, these two materials are currently the only ones that can be recycled by type, unlike comparable board materials. With specially developed polyamide fittings, matching aluminium profiles and back panels made of translucent polycarbonate, the panels can be assembled without tools to create shelving and customised room solutions.

MAKING OF



PHASE 1



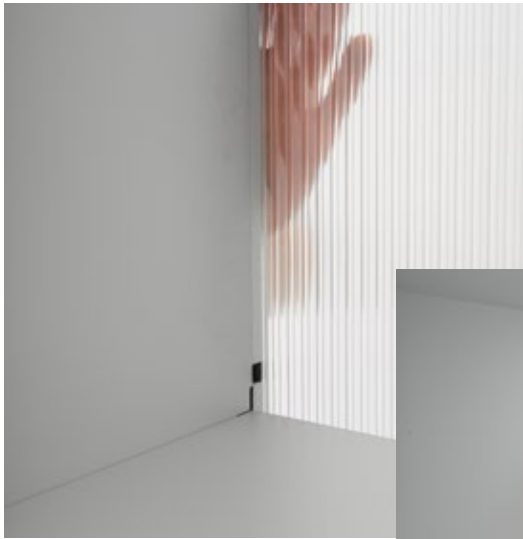

Mit dem ‚D2‘ System lässt sich eine nachhaltige Komplett-einrichtung in Leichtbauweise realisieren, von Wänden über Kabinen, bis zum Messestand. Alle Elemente werden einfach ineinander gesteckt, eine aufwändige Montage ist nicht notwendig. Die Oberfläche ist zudem individuell bedruckbar. Mit Hilfe eines Konfigurators, wird man in Zukunft das System ganz nach den eigenen Wünschen planen können.

With the ‚D2‘, a sustainable complete furnishing system can be realized in lightweight construction, from walls to booths, to exhibition stands. All elements are simply plugged into each other, no time-consuming assembly is necessary. The surface can also be individually printed. With the help of a configurator, you will be able to plan the system according to your own wishes in the future.

## Development study Mirko Borsche

„Alle reden darüber, wie ein Büro der Zukunft aussehen könnte, wir wollten die Vision in die Realität übersetzen, indem wir einen experimentellen, ergebnisoffenen Ansatz gehen.“

“Everyone is talking about what an office of the future might look like, we wanted to translate the vision into reality by taking a experimental, open-ended approach.”



Geboren ist das System „D2“ von Wagner Living in den Büroräumen des Designers Mirko Borsche in München. Das Berliner Studio von Pierre Jorge Gonzalez und Judith Haase hat gemeinsam mit Mirko Borsche, Wagner Living und Stefan Diez den Prototyp eines modernen, flexiblen Büros erdacht.

Wagner Living's „D2“ system was born in the offices of designer Mirko Borsche in Munich. The Berlin studio of Pierre Jorge Gonzalez and Judith Haase, together with Mirko Borsche, Wagner Living and Stefan Diez, conceived the prototype of a modern, flexible office.





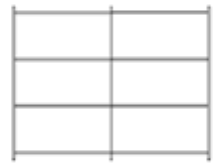
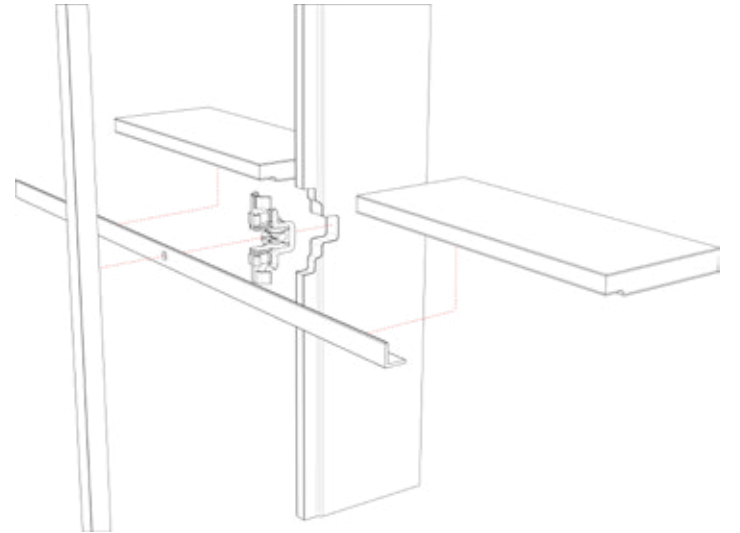

D2 Masterpiece



# PHASE 2

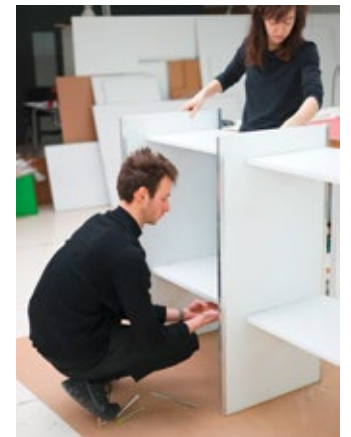



ENTWICKLUNG  
DEVELOPMENT



VERBINDER  
CONNECTOR



innovatives Stecksystem  
innovative plug-system



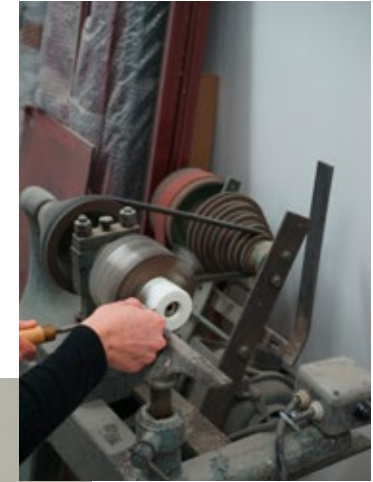





MATERIALS

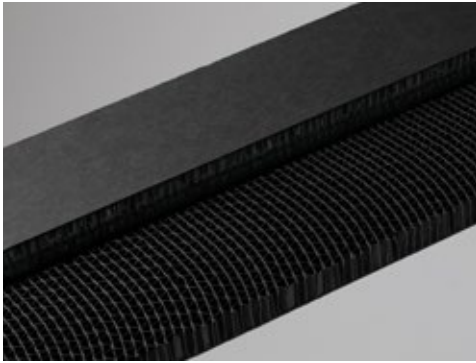

CARTON



ALUMINIUM



# OVERVIEW



VERBINDER Polyamid (PA) /  
RÜCKWÄNDE Polypropylen (PP)

CONNECTOR POLYAMIDE (PA) /  
BACK PANELS POLYPROPYLENE (PP)

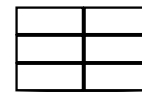

**sideboard**

office  
-----  
-----  
-----  
home office

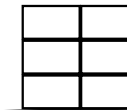

**highboard**

office  
-----  
-----  
-----  
home office

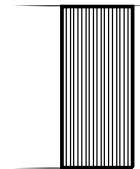

**room divider**

office  
conference  
waiting  
meeting  
-----

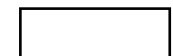

**workbench**

office  
conference  
-----  
meeting  
home office



**highbench**

office  
conference  
-----  
meeting  
home office

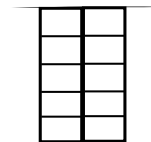

**shelf**

office  
conference  
waiting  
meeting  
home office





CASE  
STUDYS



*#wagnerdesignlab*

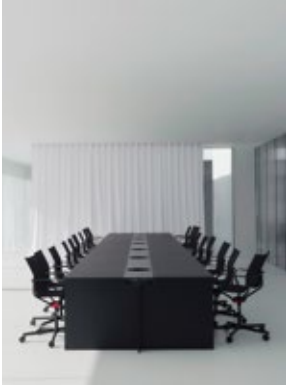

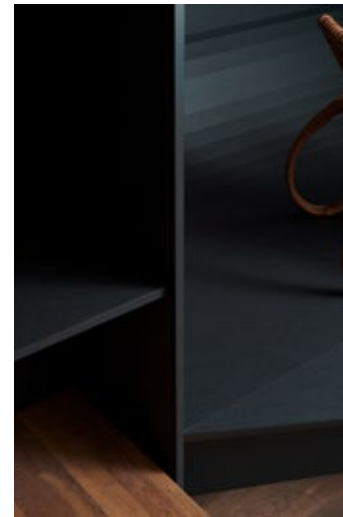

WAGNER X BAUHAUS

D2 PRESENTATION



WALTER INNOVATIONSBOGEN  
AUGSBURG  
OFFICE SPACE



STEUERBERATUNG,  
AUGSBURG  
TAX CONSULTING OFFICE SPACE





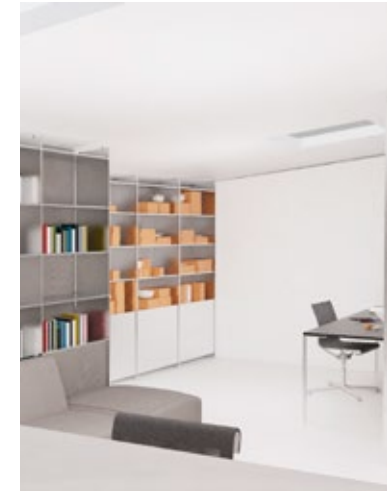

WAGNER X DIEZ OFFICE  
D2 VISUALIZATION





MEDIENHAUS KIEL  
VISUALIZATION





PROJECT AUGSBURG  
OFFICE SPACE





WAGNER X GOEVENT  
COWORKING SPACE





INTERGASTRA  
2024  
VISUALIZATION



ORGATEC 2022  
BOULEVARD

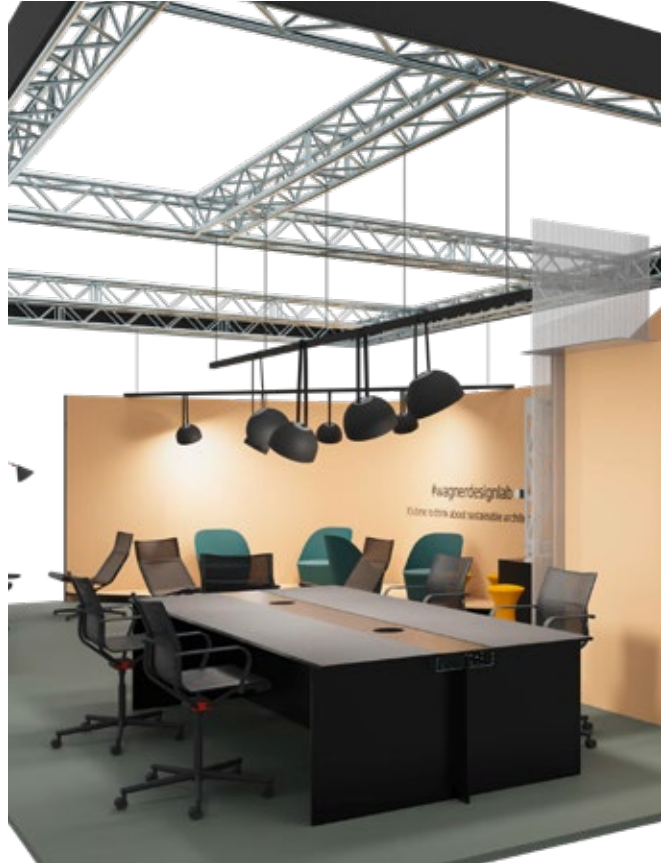
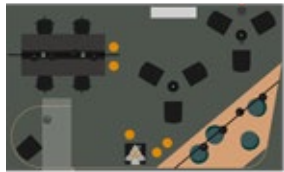

DESIGNPOST COLOGNE  
SHOWROOM FOR ORGATEC 22

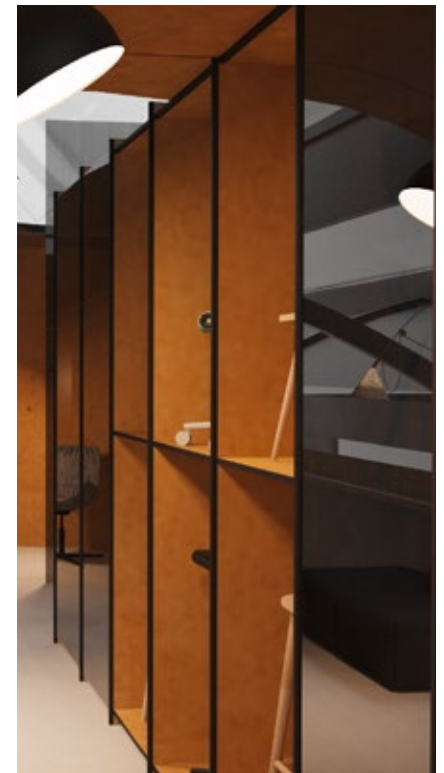
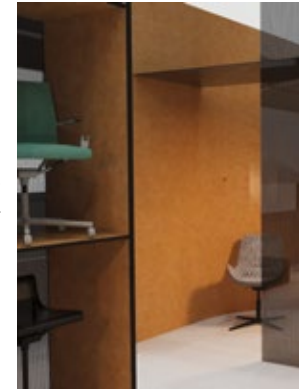

# PLANNING



# DESIGN POST COLOGNE

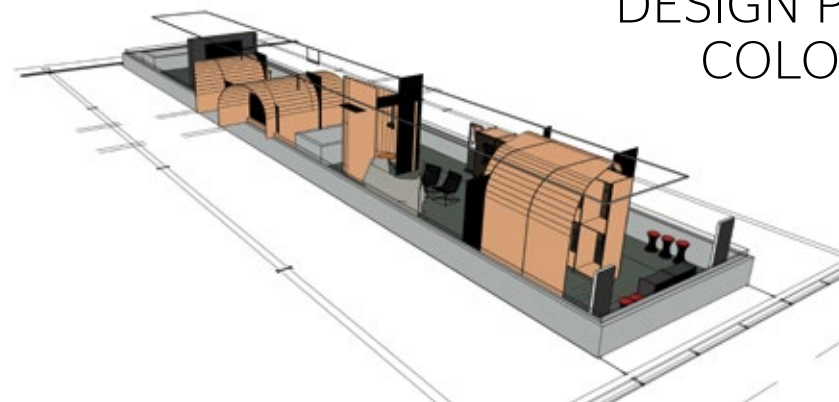

# ORGATEC 2022

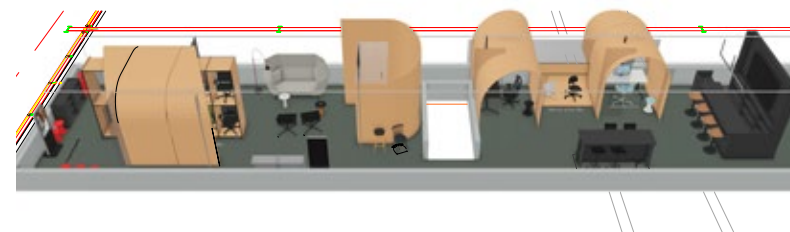

# SIDEBOARD

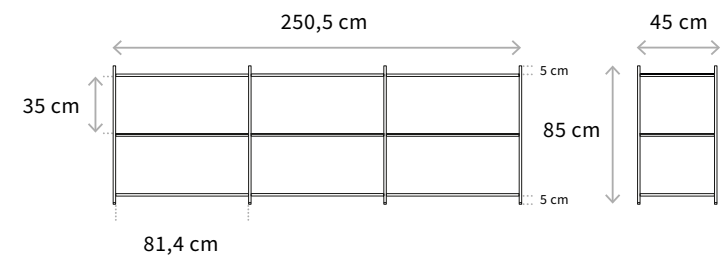

# HIGHBOARD

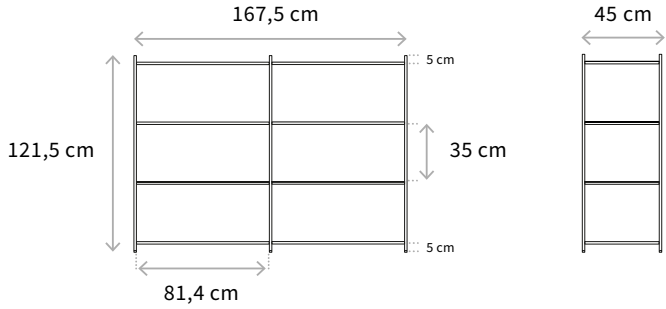





## WORKBENCH





## HIGHBENCH





## INDIVIDUAL







DANKE  
THANK YOU  
GONZALEZ HAASE AAS  
& DIEZ OFFICE



The world of **wagner d2**



**d2**

sideboard



**d2**

workbench



**d2**

highboard



**d2**

highbench



It's time for sustainable  
furniture systems.

Move your life.

wagner

[www.wagner-living.de](http://www.wagner-living.de)  
86863 Langenneufnach, Germany



wagner\_living